

# Tenso P-10

Pat. pend.

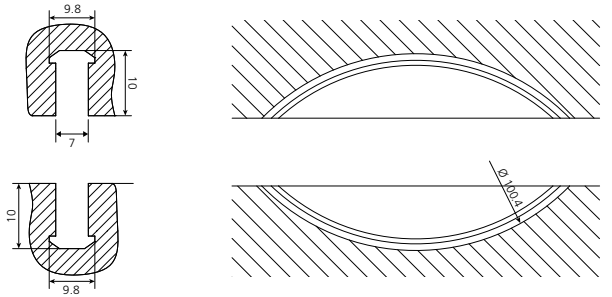
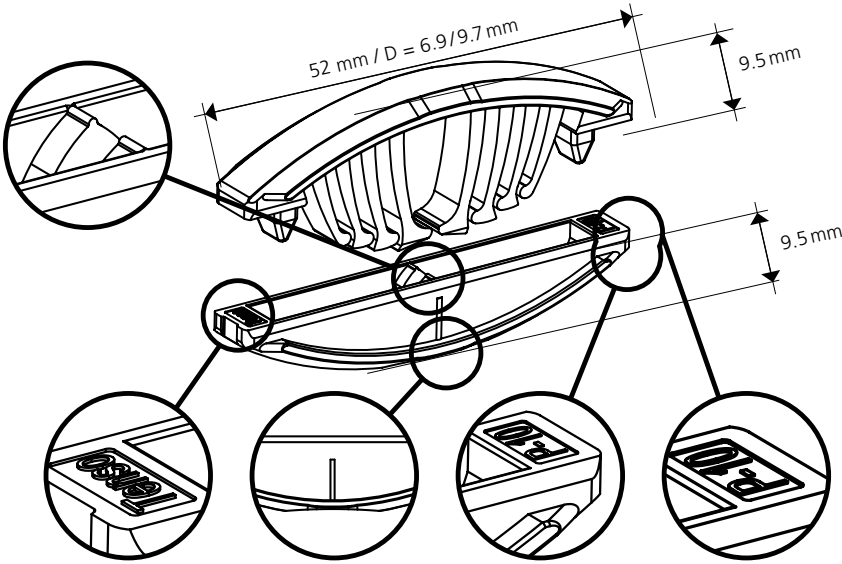
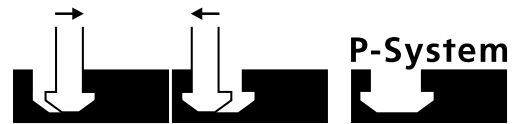

Anzugskraft / Tensile Force: 100 N

Haltekraft / Retention Force: 180 N

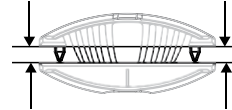

Hinweis: Die Zug- bzw. Scherfestigkeit ist abhängig vom Klebstoff / Tip: The tensile or shear strength depends on the used adhesive

## Immer in Verbindung mit Klebstoff verwenden

### Hinweis:

- Trockener Zusammenbau mit **Bisco P-10** möglich
- Bei Arbeiten mit 12 mm bzw. 13 mm dicken Materialien muss mindestens eine 1 mm Kante verwendet werden

## Always use in combination with glue

### Tip:

- Test assembly with **Bisco P-10** possible
- When working with 12 mm or 13 mm thick materials at least one 1mm edge must be used

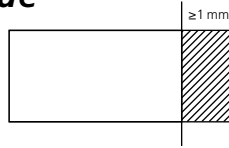

**Wichtig:** Für eine maximale Spannkraft!  
**Important:** For maximum clamping force!

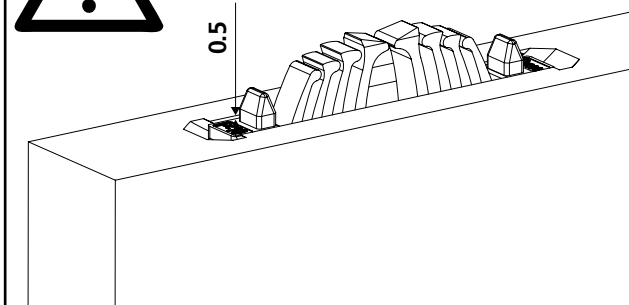

**Zeta P2**

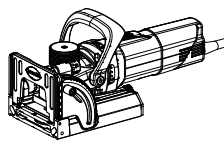

Art.Nr. 101402



Art.Nr. 132140 (Diamant)  
DP, Ø 100.4 x 7 x 22 mm



Art.Nr. 132141  
HW, Ø 100.9 x 7 x 22 mm

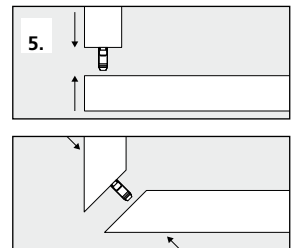
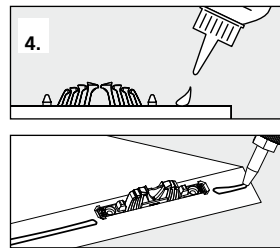
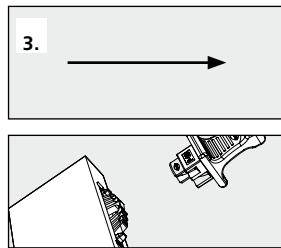
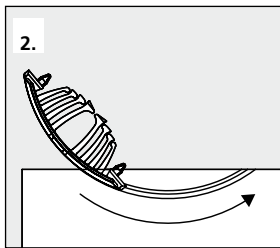
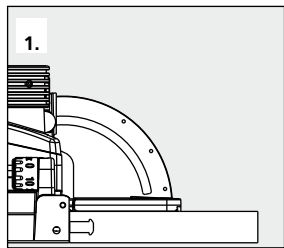
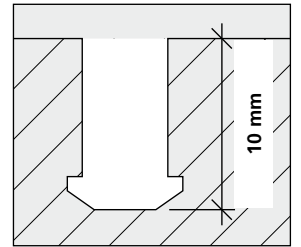
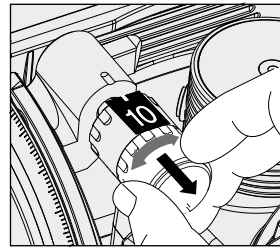

**Scharfe Fräser verwenden**  
**Use sharp cutters**



max. 30 min

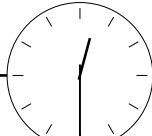

## Anwendungen / Applications

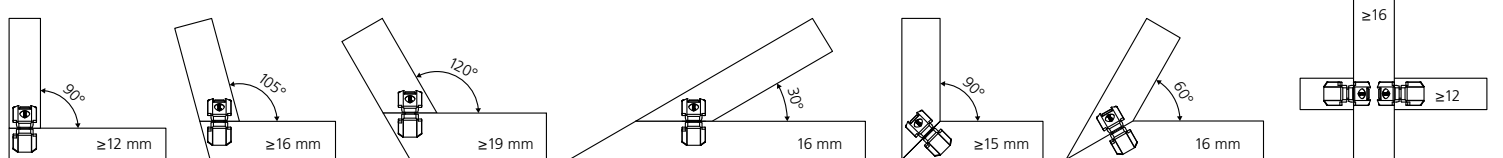

# Versetzter Einbau / Offset installation

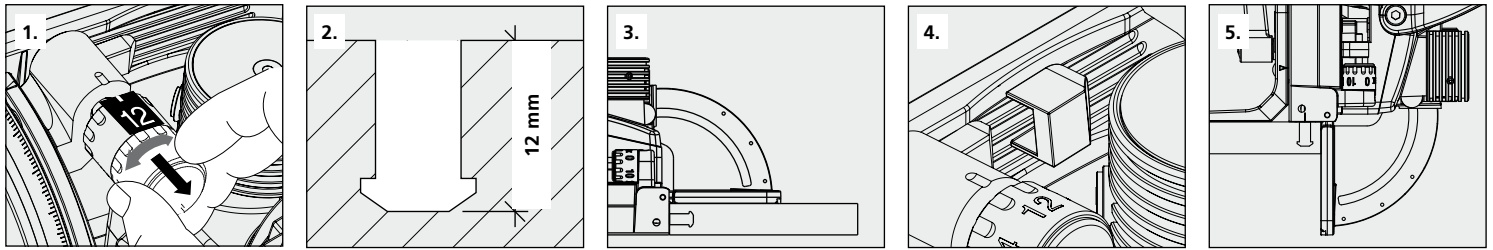

**P-12 P-8 P-12**

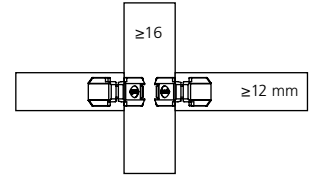
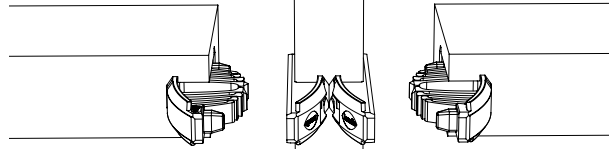
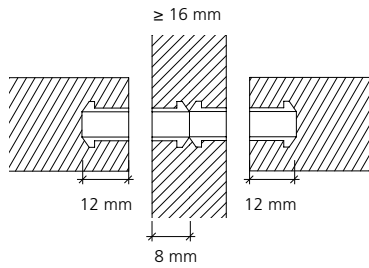

## CNC | Partner network: [www.lamello.ch](http://www.lamello.ch)

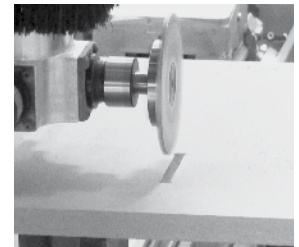
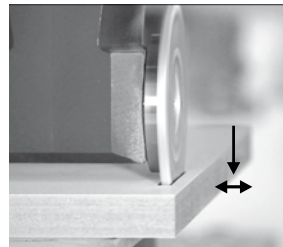
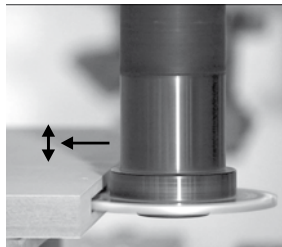
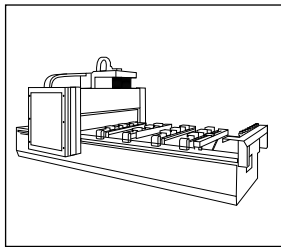

**Art.Nr. 132142**

DP, 100.4 x 7 x 30 mm  
4 / 6.6 / DTK 48 mm

\* Passend zu allen aufgeführten Fräsdornen /  
Suitable for all cutter arbors listed

**Art.Nr. 132143**

DP, 100.4 x 7 x 40 mm  
4 / 5.5 / DTK 52 mm

**Art.Nr. 132144**

DP, 100.4 x 7 x 16 mm  
4 / 5.5 / DTK 28 mm



**\* Art.Nr. 132150**

20 x 50, L = 102 mm

**\* Art.Nr. 132151**

25 x 60, L = 102 mm

**\* Art.Nr. 132152**

16 x 50, L = 85 mm

**\* Art.Nr. 132153**

16 x 55, L = 68 mm

**\* Art.Nr. 132154**

16 x 50, L = 85 mm, mit Spannfläche (2°-schräg) / with clamping surface (2°-angle)

**\* Art.Nr. 132155**

20 x 50, L = 85 mm, mit Spannfläche (2°-schräg) / with clamping surface (2°-angle)



**Art.Nr. 145439**

Tiefenstelleraufsatz /  
Depth adjuster cap

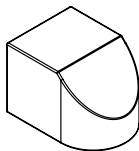

Stück/Piece/ Pièce/Pezzi	Art.Nr.
1	145439

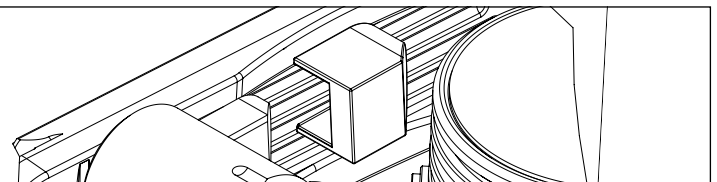

**Divario P-18**

**Tenso P-14**

**Tenso P-10**

**Clamex P Medius  
14/10**

**Clamex P-14**

**Clamex P-10**

**Bisco P-14  
Bisco P-10**

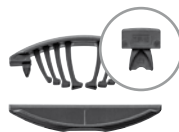

Paar/Pair/ Paire/Paio	Art.Nr.	Paar/Pair/ Paire/Paio	Art.Nr.
80	145550	80	145415
300	145560	300	145425
1000	145570	1000	145435

Paar/Pair/ Paire/Paio	Art.Nr.
80	145418
300	145428
1000	145438

Paar/Pair/ Paire/Paio	Art.Nr.
80	145370
300	145371
1000	145357

Paar/Pair/ Paire/Paio	Art.Nr.
80	145334
300	145346
1000	145356

Paar/Pair/ Paire/Paio	Art.Nr.
80	145372
300	145373
1000	145374

Stück/Piece/ Pièce/Pezzi	Art.Nr.
P-10 80	145304
300	145305
P-14 80	145301
300	145302
1000	145303